

### Features

- 100% avalanche tested
- Avalanche ruggedness
- Very low intrinsic capacitances
- High speed switching
- Very low on-resistance

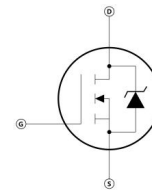
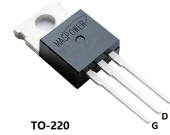
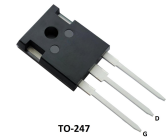

### Applications

- Welder
- UPS
- PV Inverter
- Switching applications

### Electrical ratings

Absolute maximum ratings			
Parameter	Symbol	Value	Unit
Drain-source voltage ( $V_{GS} = 0$ )	$V_{DS}$	1200	V
Gate- source voltage	$V_{GS}$	$\pm 30$	
Drain current (continuous) at $T_C = 25\text{ }^\circ\text{C}$	$I_D$	8	A
Drain current (continuous) at $T_C = 100\text{ }^\circ\text{C}$		5.5	
Drain current (pulsed)	$I_{DM}$	22	
Total dissipation at $T_C = 25\text{ }^\circ\text{C}$	$P_{TOT}$	260	W
Derating factor		2.56	W/ $^\circ\text{C}$
Operating junction temperature	$T_J$	-55 to 175	$^\circ\text{C}$
Storage temperature	$T_{stg}$		

Thermal data				
Parameter	Symbol	Value		Unit
		TO-247/ TO-263	TO-220	
Thermal resistance junction-case max	$R_{thj-case}$	0.39	0.5	W/ $^\circ\text{C}$
Thermal resistance junction-ambient max	$R_{thj-amb}$	50	62.5	
Maximum lead temperature for soldering purpose	$T_J$	300		

<b>Avalanche characteristics</b>			
<b>Parameter</b>	<b>Symbol</b>	<b>Max value</b>	<b>Unit</b>
Avalanche current, repetitive or not-repetitive (pulse width limited by $T_J$ max)	$I_{AR}$	8	A
Single pulse avalanche energy (starting $T_J = 25\text{ }^\circ\text{C}$ , $I_D = I_{AR}$ , $V_{DD} = 50\text{ V}$ )	$E_{AS}$	760	mJ

**Electrical Characteristics ( $T_{vj} = 25^\circ\text{C}$  unless otherwise specified)**

<b>On /off states</b>						
<b>Parameter</b>	<b>Symbol</b>	<b>Test conditions</b>	<b>Min</b>	<b>Typ</b>	<b>Max</b>	<b>Unit</b>
Drain-source breakdown voltage	$V_{(BR)DSS}$	$I_D = 1\text{ mA}$ , $V_{GS} = 0$	1200	-	-	V
Zero gate voltage drain current ( $V_{GS} = 0$ )	$I_{DSS}$	$V_{DS} = \text{Max rating}$ $V_{DS} = \text{Max rating}$ , $T_C = 125\text{ }^\circ\text{C}$	-	-	66	$\mu\text{A}$
Gate-body leakage current ( $V_{DS} = 0$ )	$I_{GSS}$	$V_{GS} = \pm 30\text{ V}$	-	-	$\pm 100$	nA
Gate threshold voltage	$V_{GS(th)}$	$V_{DS} = V_{GS}$ , $I_D = 250\text{ }\mu\text{A}$	3	4	5	V
Static drain-source on resistance	$R_{DS(on)}$	$V_{GS} = 10\text{V}$ , $I_D = 4\text{A}$	-	2.3	3.5	$\Omega$

<b>Dynamic</b>						
<b>Parameter</b>	<b>Symbol</b>	<b>Test conditions</b>	<b>Min</b>	<b>Typ</b>	<b>Max</b>	<b>Unit</b>
Forward transconductance	$g_{fs}$	$V_{DS} = 15\text{ V}$ , $I_D = 4$	-	7.5	-	S
Input capacitance	$C_{iss}$	$V_{DS} = 25\text{V}$ , $f = 1\text{MHz}$ , $V_{GS} = 0$	-	1320	-	pF
Output capacitance	$C_{oss}$		-	110	-	
Reverse transfer capacitance	$C_{rss}$		-	20	-	
Equivalent Output capacitance	$C_{oss\text{ eq.}}$	$V_{GS} = 0$ , $V_{DS} = 0$ to $1200\text{V}$	-	118	-	
Gate input resistance	$R_g$	$f = 1\text{MHz}$ Gate DC Bias = 0 Test signal level = 20mV open drain	-	2.2	-	$\Omega$
Total gate charge	$Q_g$	$V_{DD} = 1200\text{V}$ , $I_D = 8\text{A}$ $V_{GS} = 10\text{V}$	-	89.3	-	nC
Gate-source charge	$Q_{gs}$		-	15.8	-	
Gate-drain charge	$Q_{gd}$		-	50.3	-	

Switching times						
Parameter	Symbol	Test conditions	Min	Typ	Max	Unit
Turn-on delay time	$t_{d(on)}$	$V_{DD} = 750 \text{ V}, I_D = 4 \text{ A},$ $R_G = 4.7 \Omega, V_{GS} = 10 \text{ V}$	-	41	-	ns
Rise time	$t_r$		-	14.7	-	
Turn-off-delay time	$t_{d(off)}$		-	86	-	
Fall time	$t_f$		-	31	-	

Source drain diode						
Parameter	Symbol	Test conditions	Min	Typ	Max	Unit
Source-drain current	$I_{SD}$		-	8	-	A
Source-drain current (pulsed)	$I_{SDM}$		-	22	-	
Forward on voltage	$V_{SD}$	$I_{SD} = 6 \text{ A}, V_{GS} = 0$	-	-	1.2	V
Reverse recovery time	$t_{rr}$	$I_{SD} = 6 \text{ A}, di/dt = 100 \text{ A}/\mu\text{s}$ $V_{DD} = 60 \text{ V}$	-	980	-	nS
Reverse recovery charge	$Q_{rr}$		-	9.5	-	$\mu\text{C}$
Reverse recovery current	$I_{RRM}$		-	19.3	-	A
Reverse recovery time	$t_{rr}$	$I_{SD} = 6 \text{ A}, di/dt = 100 \text{ A}/\mu\text{s}$ $V_{DD} = 60 \text{ V}, T_J = 150^\circ\text{C}$	-	884	-	nS
Reverse recovery charge	$Q_{rr}$		-	8.2	-	$\mu\text{C}$
Reverse recovery current	$I_{RRM}$		-	18.6	-	A

### Order information

<b>MS8N120FC</b>	TO-247		
<b>MS8N120FT</b>	TO-220		
<b>MS8N120FE</b>	TO-263		

### Electrical characteristics

1. Output Characteristics @ 25°C

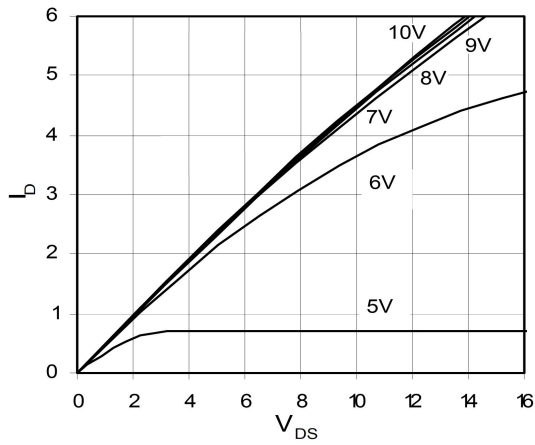

2. Extended Output Characteristics @ 25°C

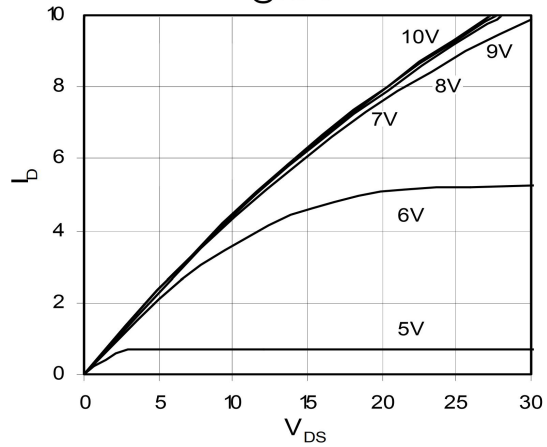

3. Output Characteristics @ 125°C

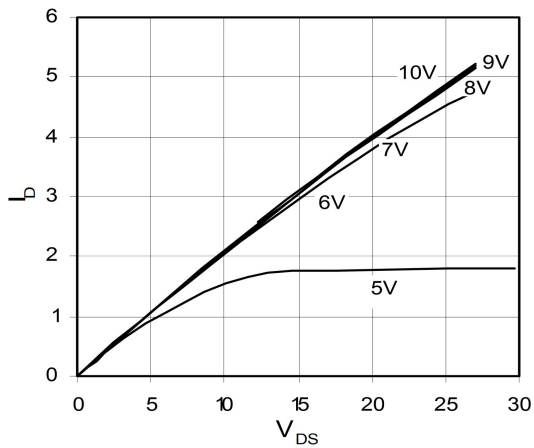

4.  $R_{DS(on)}$  Normalized to  $I_D$  Value vs. Junction Temperature

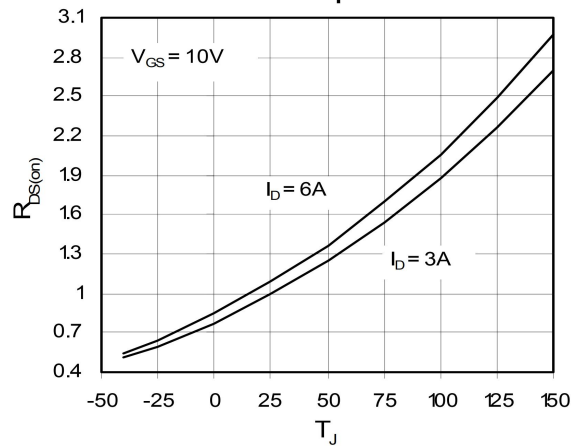

5.  $R_{DS(on)}$  Normalized to  $I_D$  Value vs.  $I_D$

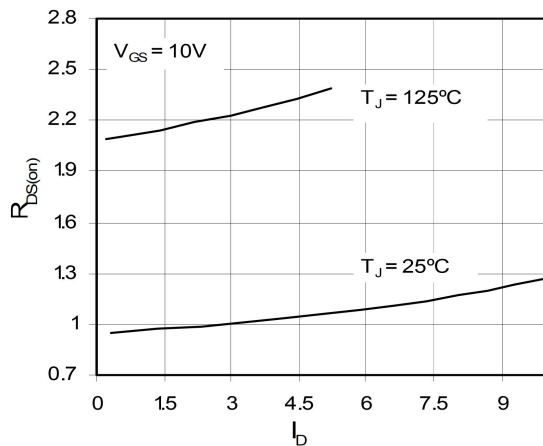

6. Drain Current vs. Case Temperature

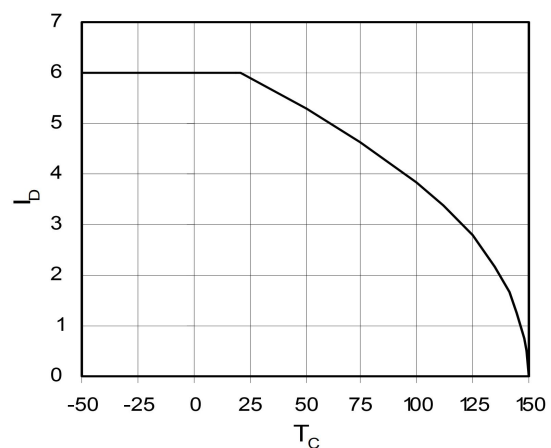

### 7. Input Admittance

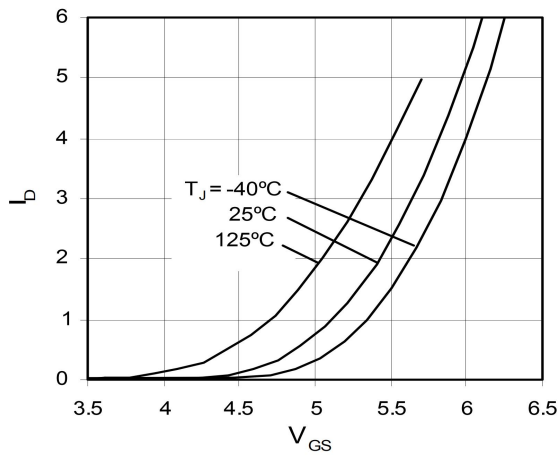

### 8. Transconductance

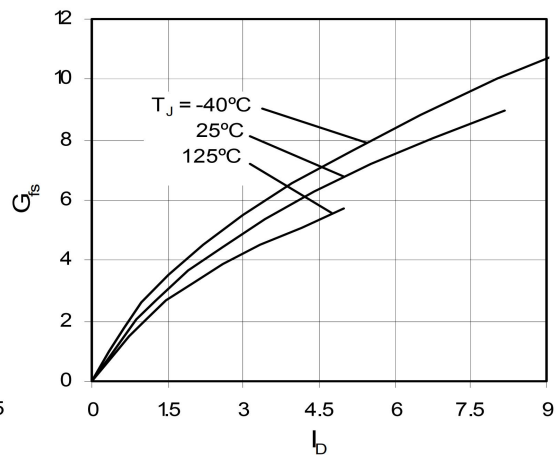

### 9. Source Current vs. Source-To-Drain

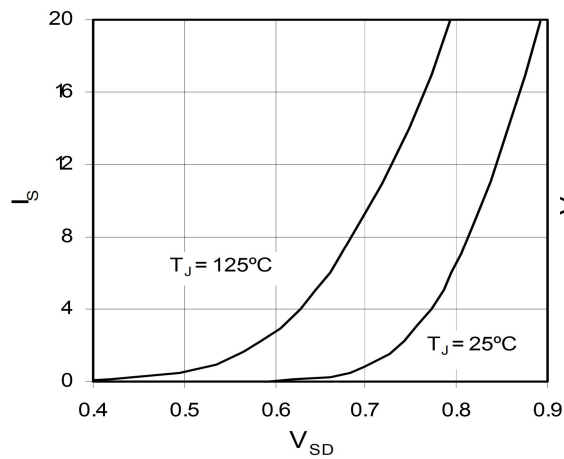

### 10. Gate Charge

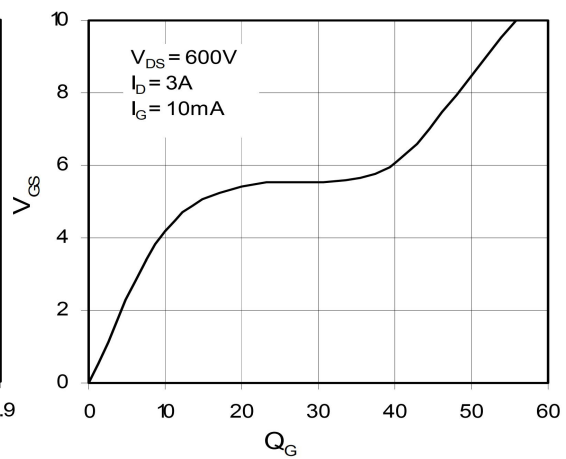

### 11. Capacitance

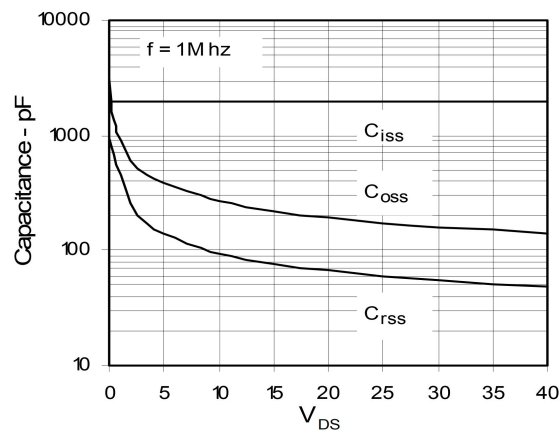

### 12. Maximum Transient Thermal Resistance

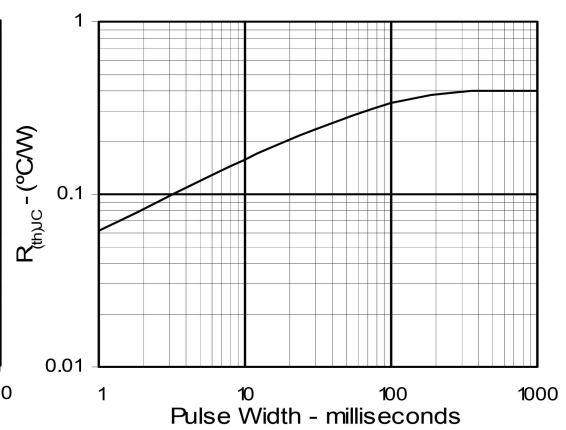

### Package outline dimension

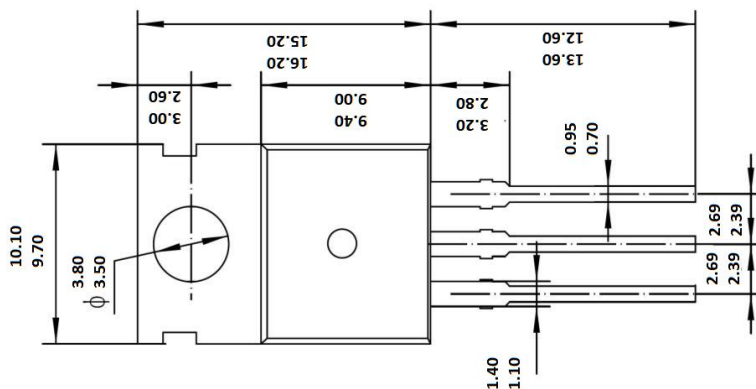
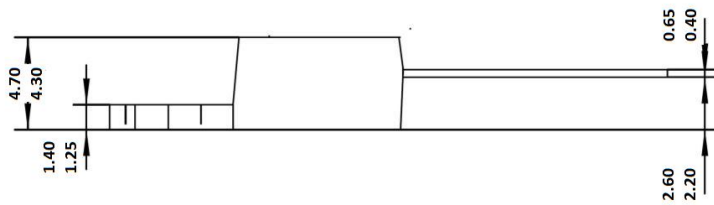
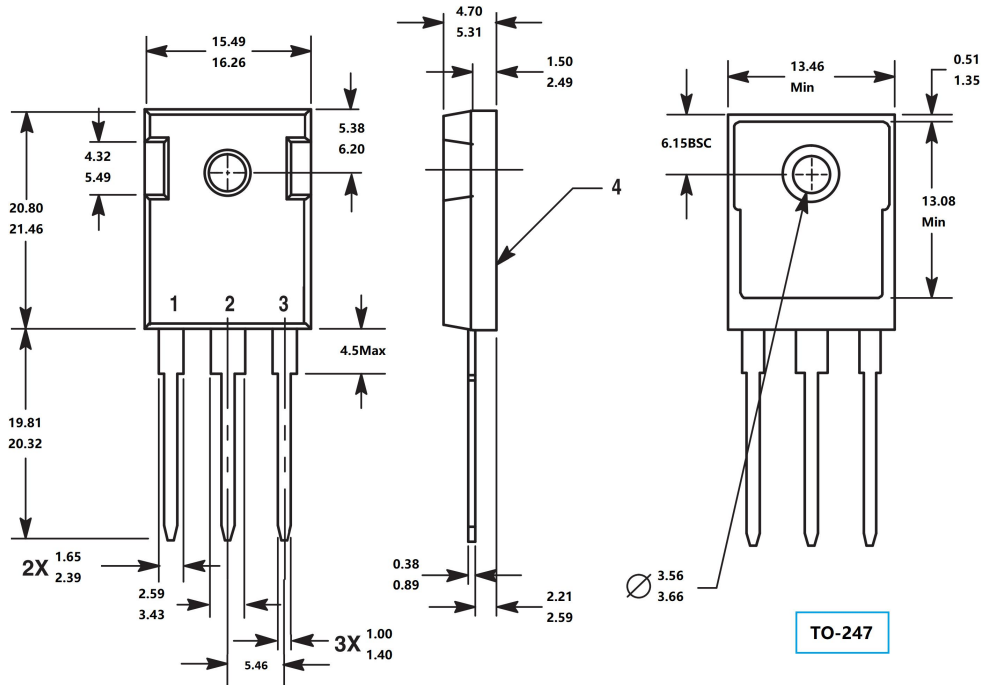

Unit: mm

TO-220



